

FIRESLIDE EI30

Installation V

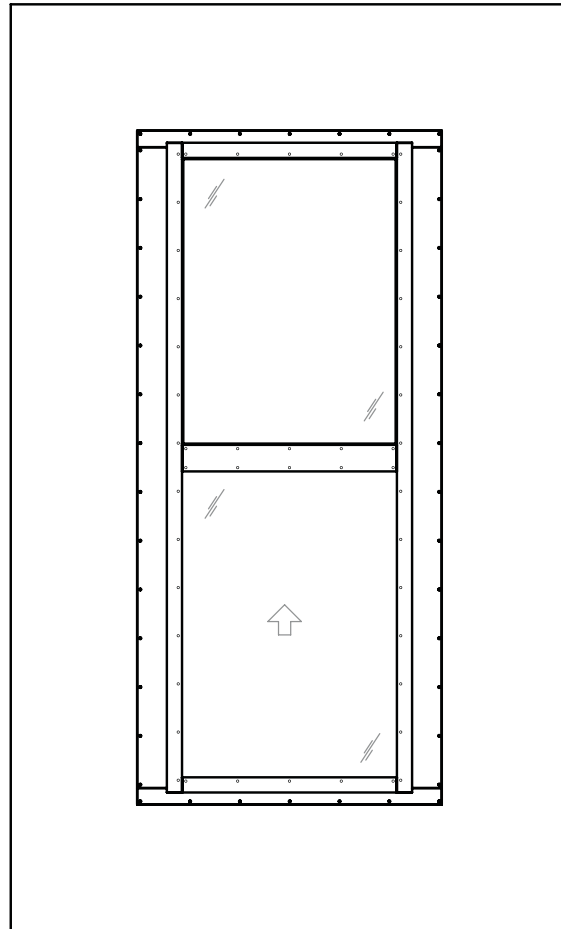

(EN) Not Included

- A. Plaster/Gypsum -board
 - B. Steel or wooden frame
 - C. Mineral wool
 - D. EN-13501 Material Class \geq D
e.g. high density wood.
 - E. Drywall screw
 - F. Nail - 30mm
-

(FR) Non inclus

- A. Placoplatre
 - B. Châssis en bois ou en acier
 - C. Laine de roche (laine de verre)
 - D. EN-13501 Materiel Class \geq D
e.g bois haute densité
 - E. Vis pour plaques de plâtre
 - F. Ongle - 30mm
-

(ISL) Ekki innifalð

- A. Gipsplata
 - B. Stál- eða treverk
 - C. Steinull
 - D. EN-13501 efnisflokkur \geq D
 - E. Gipsskrúfa
 - F. Nagli – 30mm
-

(FI) Ei sisälly

- A. Kipsilevy
- B. Teräs- tai puukehys
- C. Mineraalivilla
- D. EN -13501
Materiaaliluokitus \geq D
esim. tiheä puu
- E. Kipsilevyruuvit
- F. Naulat - 30mm

(SV) Ingår ej

- A. Gipsskiva
 - B. Stål eller träregel
 - C. Mineralull
 - D. EN-13501 Materialklass \geq D
t.ex. högdensitets trä.
 - E. Gipsskruv
 - F. Spik - 30mm
-

(DE) Nicht enthalten

- A. Gipskartonplatten
 - B. Stahl- oder Holzrahmen
 - C. Mineralwolle
 - D. Nach DIN EN -13501
Materialklassifizierung \geq D
z. B. hoch verdichtetes Holz
 - E. Schnellbauschrauben
 - F. Nagel - 30mm
-

(NO) Ikke inkludert

- A. Gipsplate
 - B. Stål- eller tre stender
 - C. Mineralull
 - D. EN-13501 Materialklasse \geq D
for eksempel høydensitets tre
 - E. Gipsskruer
 - F. Spiker - 30mm
-

(EE) Ei sisaldu

- A. Kipsplaat
- B. Teras- või puitraam
- C. Mineraalvill
- D. NE-13501 Materjali klass \geq D
Kõrgtihedusega puit
Kõrgsurveplaat
- E. Kipsikruvid
- F. Naelad – 30mm

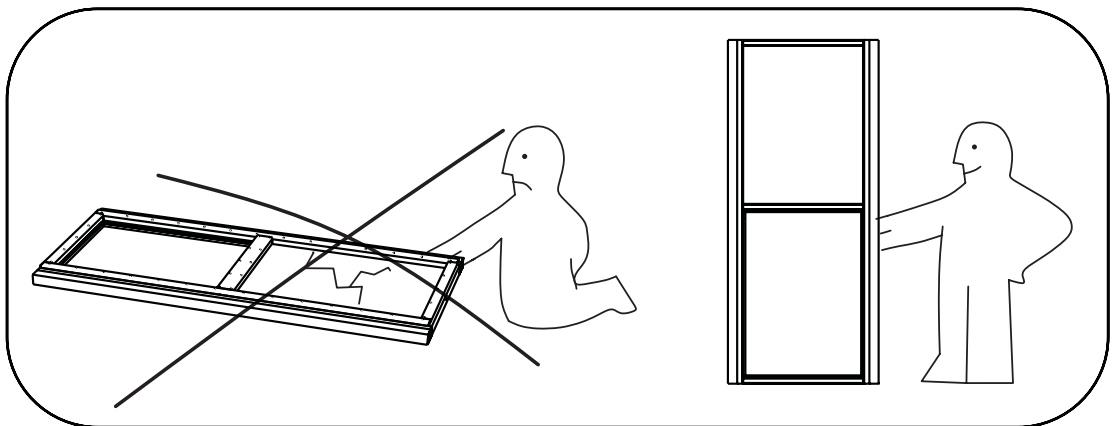
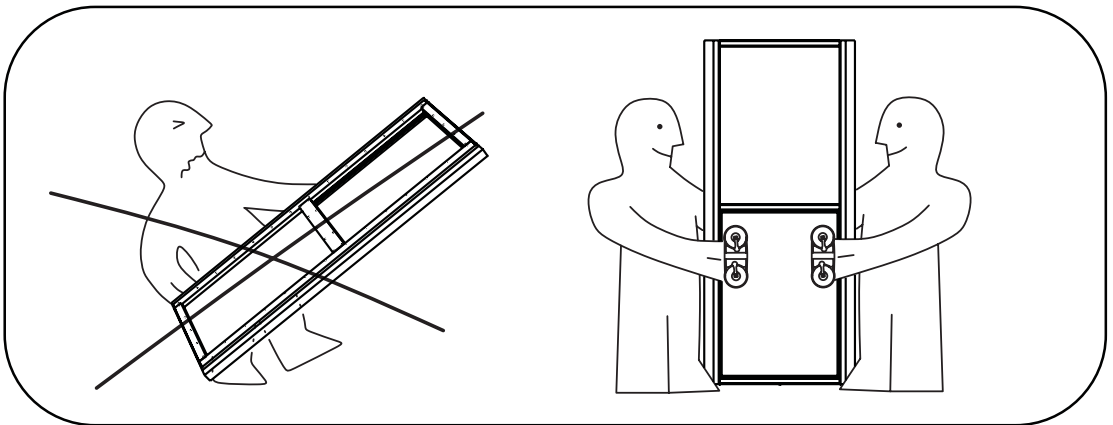
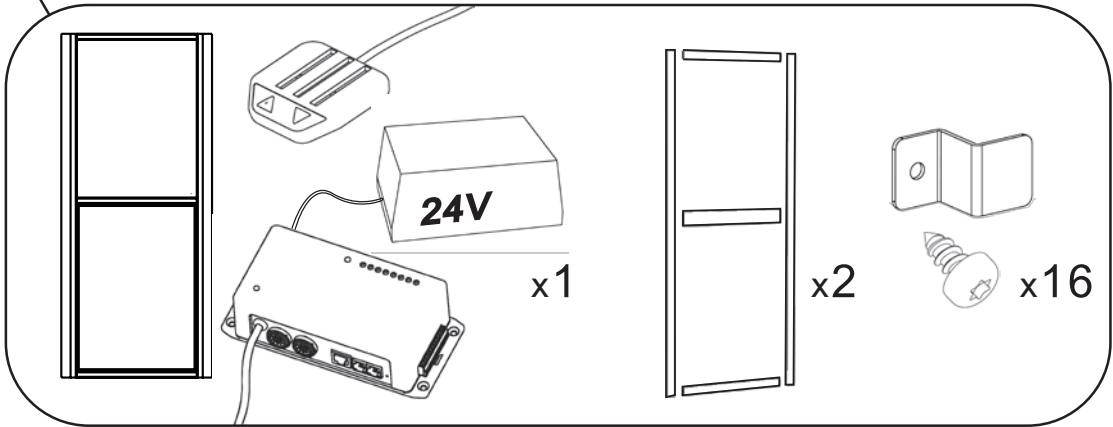
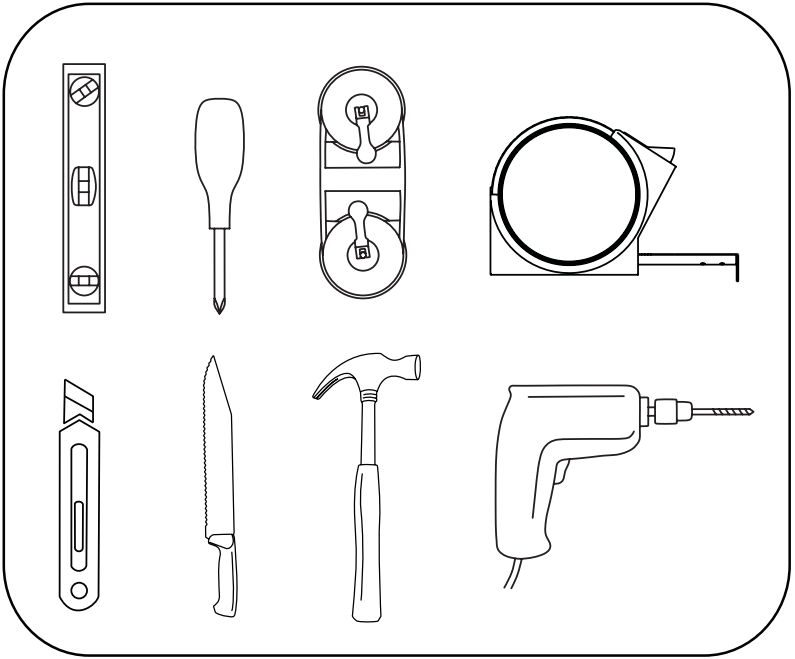
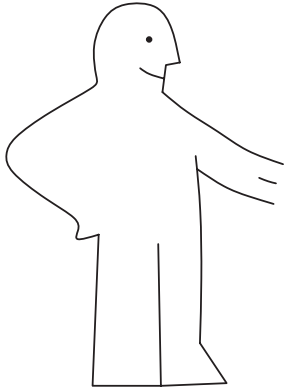
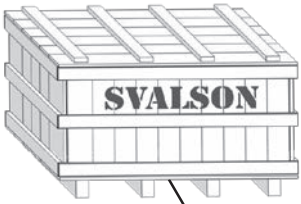

4

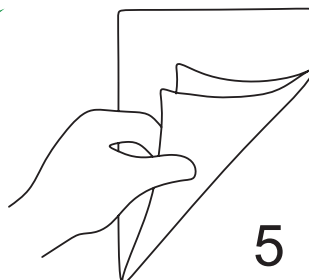
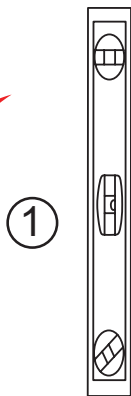
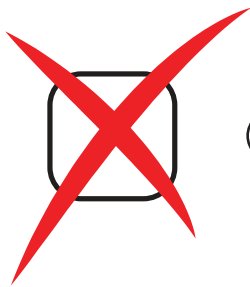
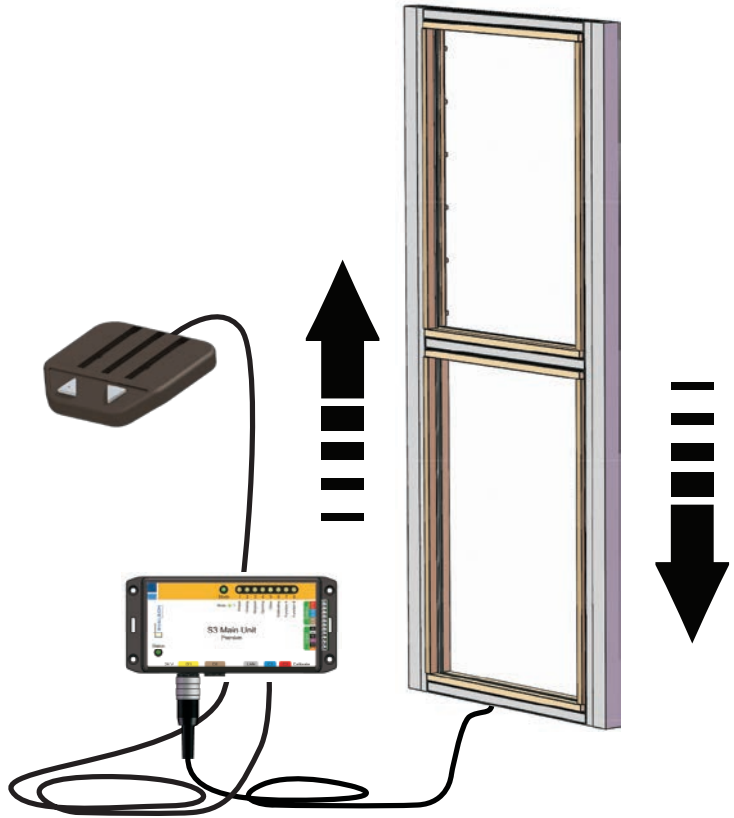
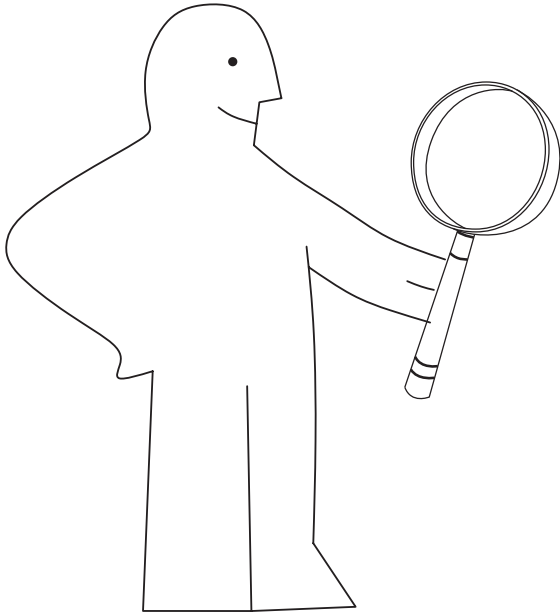

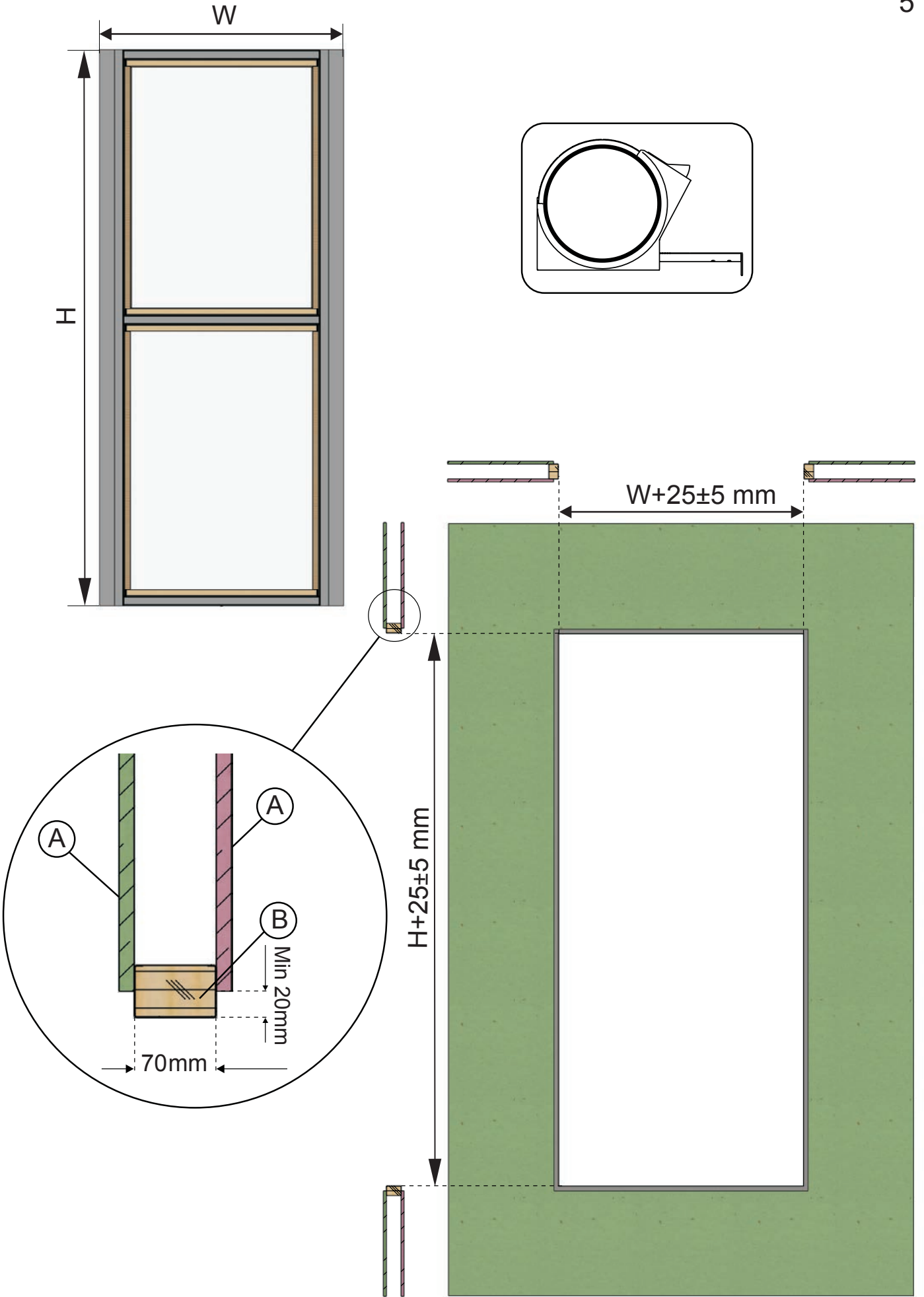

6

